

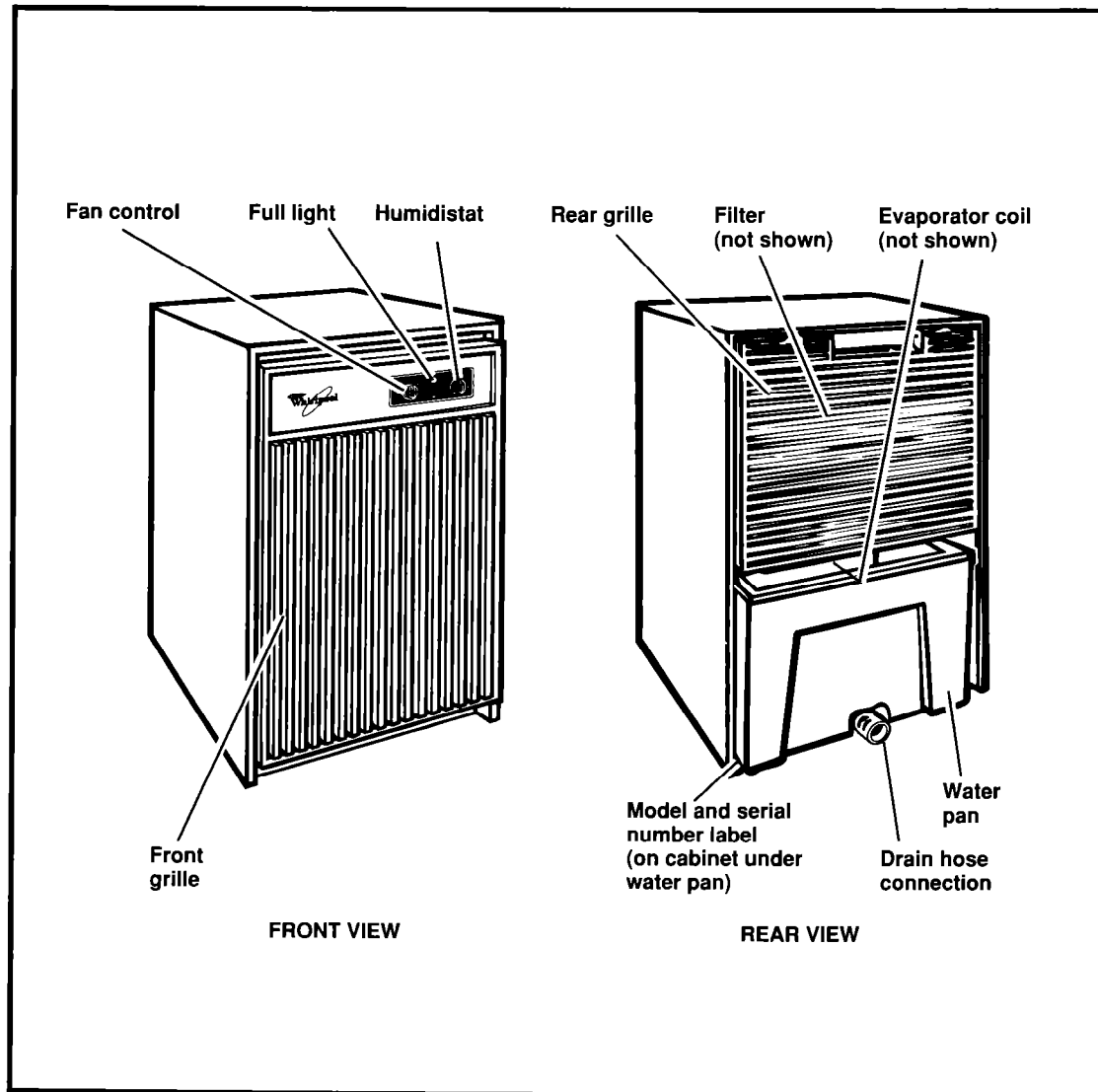

Use & Care Guide



DEHUMIDIFIER

Contents

Important Safety Instructions	2
Before Using Your Dehumidifier	3
Install properly	3
Electrical requirements	4
Using Your Dehumidifier	5
Control panel	6
Unit operation	6
De-icer control	7
Setting the water level adjustment	7
Water disposal methods	8
Caring For Your Dehumidifier	9
If You Need Service Or Assistance	11
Whirlpool Dehumidifier Warranty	12

© 1991 Whirlpool Corporation

Thank you for buying a Whirlpool dehumidifier. Please complete the form below. Have this information ready if you need service or call with a question.

- Copy model and serial numbers from label (see diagram on front cover) and purchase date from sales slip.
- Keep this book and sales slip together in a handy place.

Model Number

Serial Number

Purchase Date

Service Company Phone Number

Important Safety Instructions

⚠ WARNING

To reduce the risk of fire, electrical shock or personal injury when using your dehumidifier, follow these basic precautions:

- Read all instructions before using your dehumidifier.
- Complete the installation and electrical requirements as described in "Before Using Your Dehumidifier" on pages 3 and 4.
- Never allow children to operate or play with the dehumidifier.
- Never clean dehumidifier parts with flammable fluids. The fumes can create a fire hazard or explosion.

• FOR YOUR SAFETY •

DO NOT STORE OR USE GASOLINE OR OTHER FLAMMABLE VAPORS AND LIQUIDS IN THE VICINITY OF THIS OR ANY OTHER APPLIANCE. THE FUMES CAN CREATE A FIRE HAZARD OR EXPLOSION.

It is your responsibility to be sure your dehumidifier:

- Has been properly installed on a floor, table or shelf that is level and strong enough to support unit with a full pan of water. Unit can weigh between 22.5 kg (50 lbs.) and 33.8 kg (75 lbs.), depending on the amount of water collected in the pan.
- Is the correct size for the area you want to dehumidify.
- Is connected to the proper kind of outlet, with the correct electrical supply and grounding. (See "Electrical requirements" on page 4.)
- Is used only for jobs expected of home dehumidifiers.
- Is not used by children or anyone unable to operate it properly.
- Is properly maintained.
- Is used in an area where the room temperature will not fall below 18.3°C (65°F).

- SAVE THESE INSTRUCTIONS -

DO NOT REMOVE TECH SHEET from inside cabinet. Your service technician will need this information.

Before Using Your Dehumidifier

Install properly

⚠ WARNING

Personal Injury Hazard

Because your dehumidifier weighs between 22.5 kg (50 lbs.) and 33.8 kg (75 lbs.), depending on the amount of water collected in the pan, it is recommended that you use proper lifting techniques when lifting or moving your unit. Failure to do so could result in personal injury.

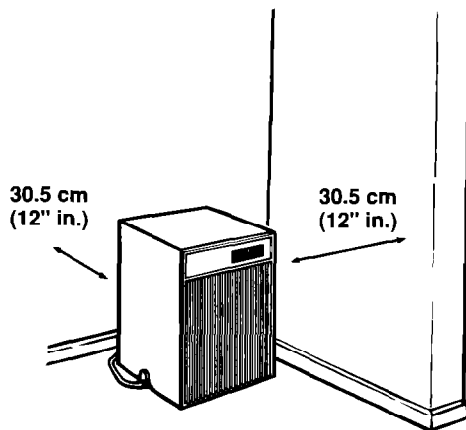

1. Allow at least 30.5 cm (12 inches) of space on all sides of the unit for good air circulation.
2. Install the unit on a floor, table or shelf. When installing the unit on a table or shelf, be sure it is strong enough to support the unit with a full pan of water. A table or shelf may be a better position from which to handle the water pan. Do not sit or stand on this product. The height of a table or shelf may help prevent icing of coils due to colder air near the floor (such as can be found in a basement).
3. Keep all outside doors, windows and other openings closed when dehumidifier is operating. Humid outdoor air will add to the dehumidifier's operating load.
4. **The water pan must be properly positioned**, on the hangers inside the cabinet, when dehumidifier is operating in order for the automatic shut-off to operate correctly.
5. All models have four casters which allow easy movement of dehumidifier.

IMPORTANT SAFETY INSTRUCTIONS • BEFORE USING YOUR DEHUMIDIFIER

**Before Using Your Dehumidifier
Continued**

Electrical requirements

OBSERVE ALL GOVERNING CODES AND ORDINANCES.

Electrical ground is required on this appliance.

A 115 volt, 60 Hz., AC only, 15 ampere fused electrical supply is recommended. (Time delay fuse or circuit breaker is recommended.) It is recommended that a separate circuit serving only this appliance be provided. **Do not use an extension cord.**

DO NOT, UNDER ANY CIRCUMSTANCES, REMOVE THE POWER SUPPLY CORD GROUND PRONG.

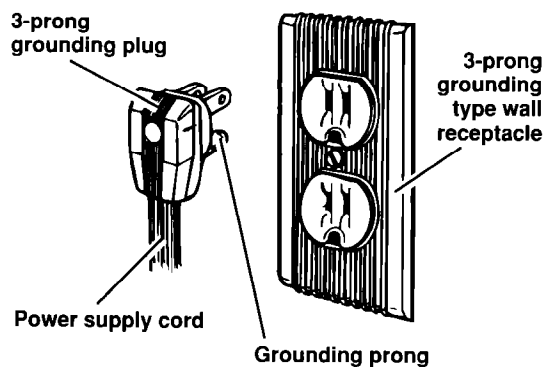

Recommended grounding method

For your personal safety, this appliance must be grounded. This appliance is equipped with a power supply cord having a 3-prong grounding plug. To minimize possible shock hazard, the cord must be plugged into a mating grounding type wall receptacle, grounded in accordance with all local codes and ordinances. If a mating wall receptacle is not available, it is the responsibility of the customer to have a properly grounded, 3-prong wall receptacle installed by a qualified electrician.

Using Your Dehumidifier

You will use your dehumidifier more during months when you're not heating your home. However, your dehumidifier can help prevent excessive moisture and keep you comfortable all year long, in any area of your home.

- Use in a basement to help prevent moisture damage.

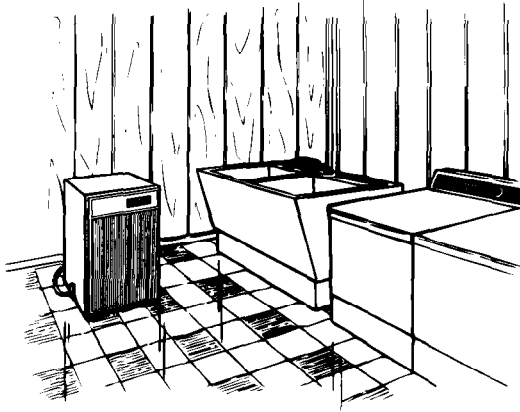

- Use in cooking, laundry, bathing and dishwashing areas which have excess moisture.

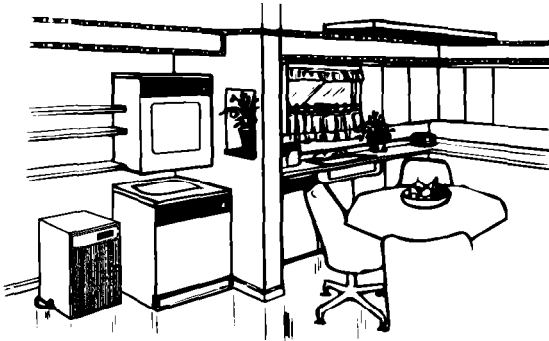

- Use to prevent moisture damage anywhere books or valuables are stored.

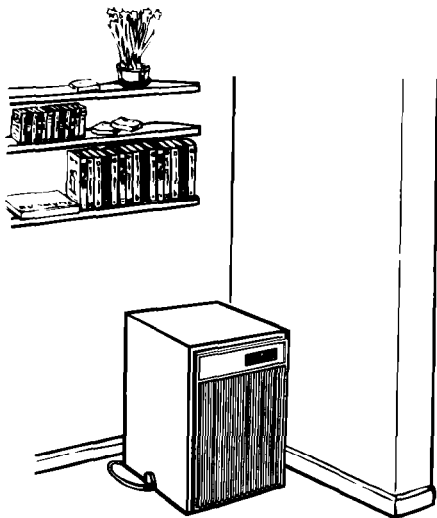

BEFORE USING YOUR DEHUMIDIFIER • USING YOUR DEHUMIDIFIER

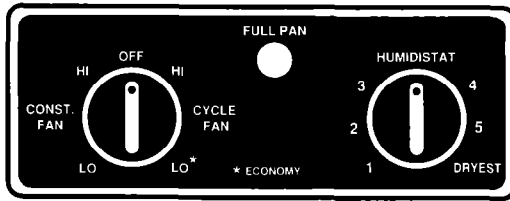

Control panel

Your dehumidifier has a control panel containing three controls—the Fan Control, Full Pan Light and the Humidistat.

Fan Control—This controls fan operation. It has three modes:

- **CONST FAN** mode causes the fan to run at all times while the compressor runs only to satisfy the Humidistat setting. Use HI for faster drying. Use LO for quieter operation.
- **CYCLE FAN** mode causes the fan to cycle on and off with the compressor to satisfy the Humidistat setting. This mode can save energy by not running the fan constantly. Use HI for faster drying. Use LO for quieter operation and most energy savings.
- **OFF** turns the dehumidifier off until it is turned on again.

Full Pan Light—This light glows when the water pan is full and needs to be emptied.

Humidistat—This controls the amount of moisture in the room. When the humidity in the room increases, the unit automatically starts. When the humidity decreases to the selected level, the unit automatically stops. The unit will run constantly at the DRYEST setting.

Unit operation

1. Turn the Fan Control to OFF. Plug power supply cord into electrical outlet. Be sure to use the correct grounding technique. (See page 4.)
2. Turn the Fan Control to the desired mode and setting.
3. Turn the Humidistat to the desired number setting (or DRYEST). If you need more dehumidification, turn Humidistat to a higher number. If you need less dehumidification, turn Humidistat to a lower number.

NOTE: For the first few days of use, turn the Humidistat to DRYEST. This will remove excess moisture from the furnishings as well as the room air.

4. Stop the unit manually by turning the Fan Control to OFF.

De-icer control

⚠ CAUTION

Do not operate dehumidifier at temperatures below 18.3°C (65°F). The coils may become iced over and unit will not operate properly.

Your Whirlpool dehumidifier is equipped with a feature to help you get the most comfort from your new appliance by permitting it to operate down to 18.3°C (65°F). If your dehumidifier runs when room temperature and humidity conditions are low, frost can form on its evaporator coil. This interferes with proper operation.

The De-icer Control senses frost build-up on the evaporator coil and automatically shuts off the compressor. The fan continues to run, drawing air across the coil and melting the frost. When the coil is defrosted, the compressor is automatically restarted, and dehumidifying is resumed.

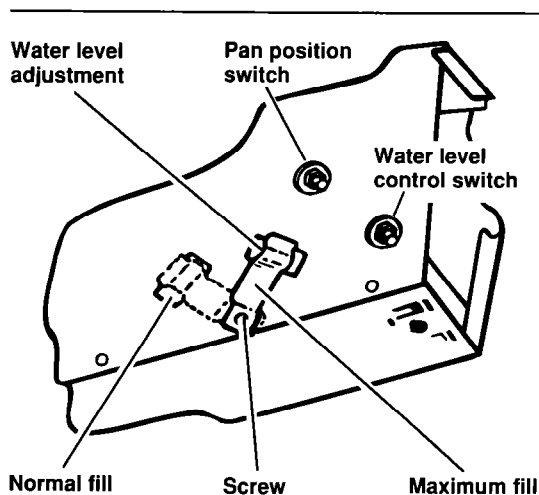

Setting the water level adjustment

The Water Level Adjustment can be set in two positions to turn off the unit automatically when the pan is full. This prevents the danger of overflow.

Pan must be in proper position for Water Level Control Switch to work.

- **NORMAL FILL**—set Water Level Adjustment to the indentation on the left side. The water pan and water will weigh approximately 7.2 kg (16 lbs.) and water pan will be 1/2 full.
- **MAXIMUM FILL**—set Water Level Adjustment to the raised area on the right side. The water pan and water will weigh approximately 10.8 kg (24 lbs.) and water pan will be 3/4 full.

The Water Level Control Switch will automatically turn off the dehumidifier at the fill level you selected when pan is properly placed. Loosen the screw to move the Water Level Adjustment. Retighten screw when adjusted to desired setting.

Water disposal methods

⚠ WARNING

Personal Injury Hazard

Do not use the water that collects in the water pan for drinking purposes. It is not sanitary and could cause illness.

There are three methods of disposing of water.

1. Empty pan manually.

When pan is full, remove it, empty it into a large sink or tub and replace it properly.

NOTE: Water pan **must** be pushed in all the way (pressing against the Pan Position Switch) in order for the unit and the Water Level Control Switch to operate.

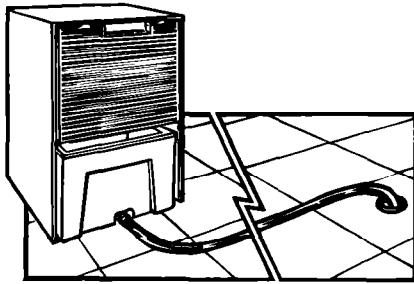
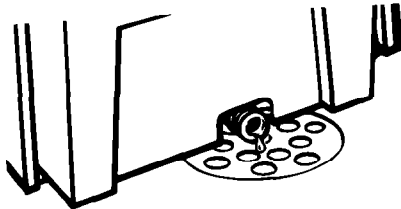
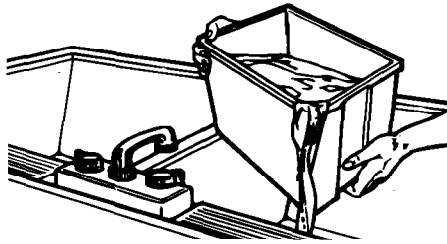

2. Place unit directly over drain.

Pan has a threaded hose connection which can be left open. Cut out opening with a knife or 19 mm (3/4") wood drill. Once opened, hose connection will continually drain water from the pan. Be sure to keep unit directly over a drain.

3. Attach garden hose to the threaded hose connection to carry water to drain.

- Pan has a threaded hose connection which can be left open. Cut out opening with a knife or 19 mm (3/4") wood drill.
- Attach garden hose. Be sure hose does not kink or bend. It should lie flat from unit to drain. (Garden hose is not included.)
- Once hose connection is opened, pan will continually drain through the hose. Be sure to keep hose flat and in drain.

Caring For Your Dehumidifier

Your dehumidifier is designed to serve you year-round. It needs practically no attention. However, you should check your dehumidifier and inspect the coils annually.

You may call a service company to perform this annual checkup or you can do it yourself. Cost of annual inspection is the owner's responsibility.
OR

If you are familiar with electrical appliances and their functions, listed below are instructions which would allow you to do the inspection and maintenance yourself.

⚠ WARNING

Electrical Shock and Personal Injury Hazard

- **Disconnect power supply cord from receptacle before performing any maintenance. Failure to do so could result in electrical shock.**
- **Be careful when cleaning the coils. Fins are sharp. Failure to do so could result in personal injury.**

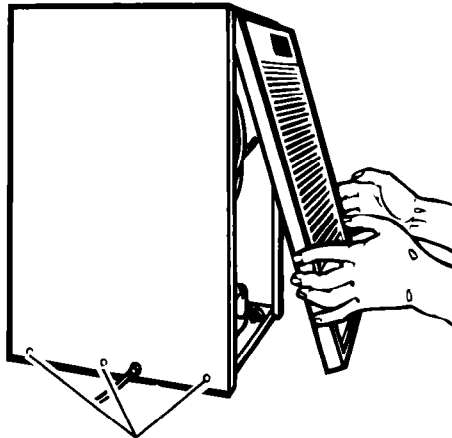

Socket head screws
(on sides of cabinet)

Top flange screws

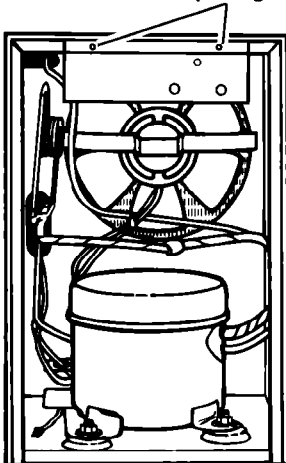

1. Disconnect power supply cord.
 2. To remove outer cabinet:
 - To take off the plastic front grille, remove the two screws at the bottom. Drop grille down and take out.
 - Remove the socket head screws on each side of cabinet.
-
- Remove the top flange screws.

Caring For Your Dehumidifier Continued

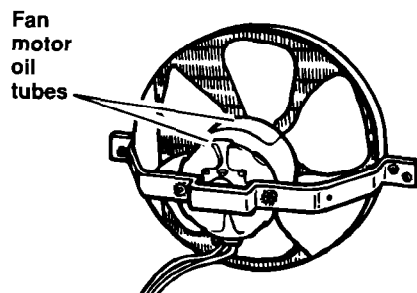
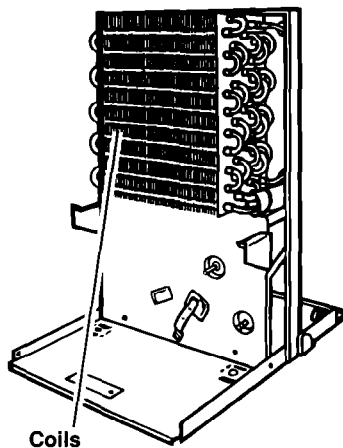
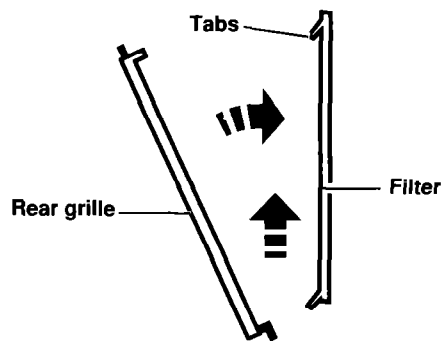
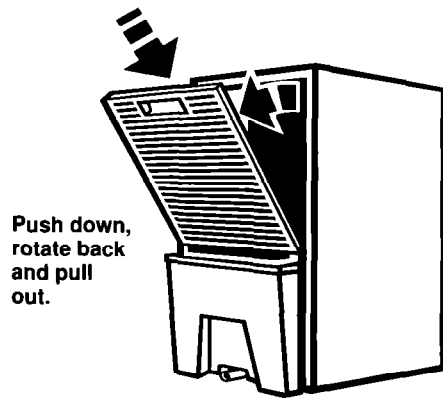

- Remove the rear grille. Push top of grille down. When tabs release from cabinet, rotate grille toward you. Detach bottom of grille from cabinet mounting pins.
- Lift cabinet from base.

3. Remove filter from back of rear grille:
 - Gently pull top of filter toward you until tabs release from grille.
 - Pull filter up and away from grille.
4. Clean filter with a vacuum cleaner or, if very dirty, wash with warm water and mild detergent. Air dry thoroughly before replacing.

5. Coils should be inspected annually. Brush clean, if necessary, with warm water and mild detergent. Rinse and dry thoroughly. **Be sure power supply cord is disconnected from receptacle.**
6. The compressor is sealed and needs no oiling. **The fan motor is prelubricated and does not require further oiling under normal operating conditions.** However, if the dehumidifier is operated under severe environmental conditions (dust, dirt, high temperatures) the fan motor should be oiled annually. Follow the instructions in step 5.

7. Oil the motor through the tubes provided. Use SAE #20 grade oil.
8. Wash plastic parts with a soft cloth, warm water and mild detergent. Rinse and dry with a soft cloth.
9. Replace cabinet, filter and grilles.
10. Reconnect power supply cord.

If You Need Service Or Assistance

We suggest you follow these steps:

1. Before calling for assistance ...

Performance problems often result from little things you can find and fix yourself without tools of any kind.

If your dehumidifier will not operate:

- Is the power supply cord plugged into a live circuit with proper voltage? (See page 4.)
- Have you checked your home's main fuses or circuit breaker box?
- Is the Fan Control set to OFF?

If your dehumidifier blows fuses or trips the circuit breaker:

- Is a time-delay fuse being used? Is it of the correct capacity?
- Is an extension cord being used? **Do not use an extension cord.**
- Are coils iced over or clogged with lint?

If the dehumidifier coils are iced over:

- Room humidity is too low. Turn unit off.
- Is room temperature too low? (See "De-icer control" on page 7.)
- Is the filter dirty?

If water collects on the floor:

- Is the unit level?
- Is the drain hose (if used) kinked?
- Is the drain clogged?
- Is the water pan overflowing?

Special dehumidifier needs:

- Annual inspection
Clean filter and coils, inspect drain and hoses. If necessary, oil the fan motor (see pages 9-10).
- Moving
When moving, keep the unit in an upright position.

2. If the problem is not due to one of the above items*...

Contact the dealer from whom you purchased the unit, or an authorized WhirlpoolSM service company.

3. If you need FSP[®] replacement parts*...

FSP is a registered trademark of Whirlpool Corporation for quality parts. Look for this symbol of quality whenever you need a replacement part for your Whirlpool appliance. FSP replacement parts will fit right and work right, because they are made to the same exacting specifications used to build every new Whirlpool appliance.

To locate FSP replacement parts in your area, contact the dealer from whom you purchased the unit, or an authorized WhirlpoolSM service company.

*When requesting assistance, please provide: model number, serial number, date of purchase, and a complete description of the problem. This information is needed to better respond to your request.

WHIRLPOOL® Dehumidifier Warranty

DH003

LENGTH OF WARRANTY	WHIRLPOOL WILL PAY FOR
FULL ONE-YEAR WARRANTY From Date of Purchase	FSP® replacement parts and repair labor to correct defects in materials or workmanship.
FULL FIVE-YEAR WARRANTY From Date of Purchase	FSP replacement parts and repair labor to correct defects in materials or workmanship in the sealed refrigeration system. These parts are: 1. Compressor 4. Drier-Strainer 2. Evaporator 5. Connecting Tubing 3. Condenser
WHIRLPOOL WILL NOT PAY FOR	
A. Service calls to: 1. Correct the installation of the dehumidifier. 2. Instruct you how to use the dehumidifier. 3. Replace house fuses or correct house wiring. B. Pick up and delivery. This product is designed to be repaired in the home. C. Damage to the Dehumidifier caused by accident, misuse, fire, flood, acts of God or use of products not approved by Whirlpool.	

Service under the full warranties must be provided by an authorized WhirlpoolSM service company.

WHIRLPOOL CORPORATION SHALL NOT BE LIABLE FOR INCIDENTAL OR CONSEQUENTIAL DAMAGES.

Outside the United States, a different warranty may apply. For details, please contact your authorized Whirlpool distributor or military exchange.

® Registered Trademark/SM Service Mark of Whirlpool Corporation